

Tay vịn nhà vệ sinh XY32-30

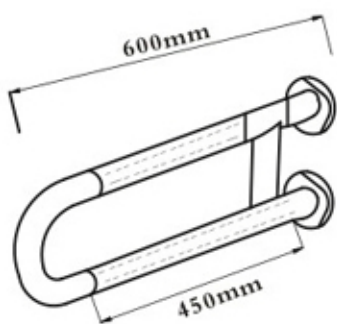

Chất liệu: lõi Nhôm

Bề mặt: Nylon

Màu sắc: Trắng, vàng



COMPACT HPL IMPORT-EXPORT.,JSC

